

### Model number parameter list:

Item	Model No.	Input Voltage	Watt	CCT	control mode	Beam Angle	Weight
1	TC-WW-36W-RGBW-BT-BK	100-277V AC	36W	RGBW-2700K-5700K	tuya	60°	7.49 lbs
2	TC-WW-72W-RGBW-BT-BK	100-277V AC	72W	RGBW-2700K-5700K	tuya	60°	8.15 lbs

■ This LED Wall washer light uses the latest in solid state lighting technology for long life, low maintenance, and high efficiency.

■ Suitable for, 100-277 VAC, 50 / 60 Hz

■ Suitable for use in the following locations:

- Ambient Temp: -40°F~+104°F

- Wet location

**Note:** Save these instructions for future reference.

### 1. Installation

#### **Warning:**

To avoid the risk of fire, explosion, or electric shock, this product should be installed, inspected, and maintained by a qualified electrician only, in accordance with all applicable electrical codes.

#### **Warning:**

To avoid electric shock:

- Be certain electrical power is OFF before and during installation and maintenance.
- Luminaire must be connected to a wiring system with an equipment-grounding conductor.

#### **Warning:**

To avoid explosion:

- Make sure the supply voltage is the same as the rated luminaire voltage.
- Do not install where marked operating temperatures exceed the ignition temperature of the hazardous atmosphere.
- Do not operate in ambient temperatures above those indicated on the luminaire nameplate.
- Keep lens tightly closed when in operation.

#### **CAUTION:**

THIS PRODUCT MUST BE INSTALLED IN ACCORDANCE WITH THE APPLICABLE INSTALLATION CODE BY A PERSON FAMILIAR WITH THE CONSTRUCTION AND OPERATION OF THE PRODUCT AND THE HAZARDS INVOLVED

MIN 90°C SUPPLY CONDUCTORS

For supply connections use wire rated for at least 194°F

## Installation Step:

1. Use expansion bolts to secure the fixture on mounting surface. (See Fig.1 & Fig.2)
2. Use expansion bolts to secure the fixture on mounting surface. (See Fig.3 & Fig.4)
3. Connect wires: black to line, white to neutral, and yellow / green to ground.

Connect the wire in the waterproof box. After the wiring is finished, the box should be locked and closed to prevent water from entering the box.

### Installation 1:

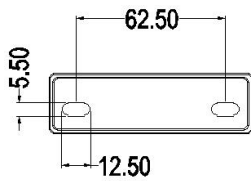

FIG.1

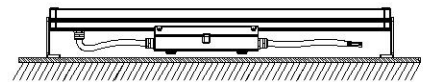
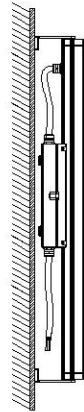
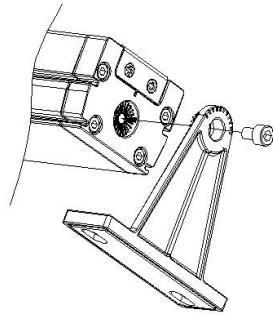

FIG.2

### Installation 2:

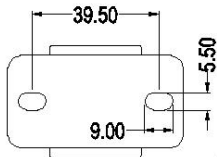

FIG.3

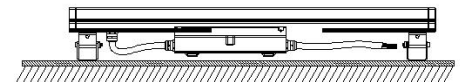
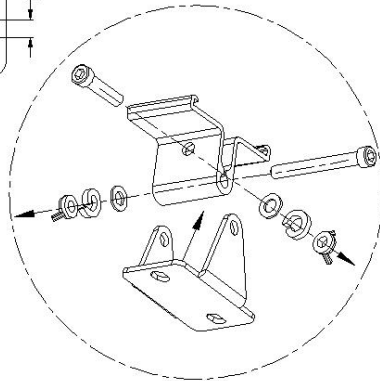

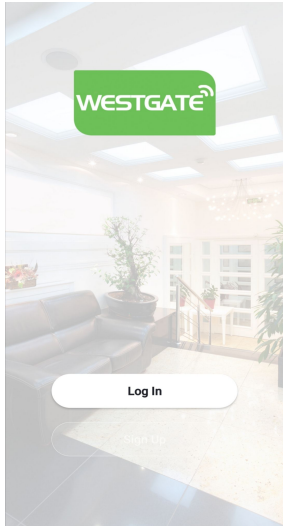
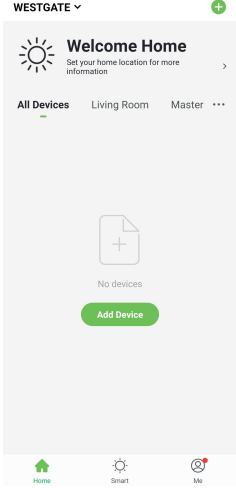
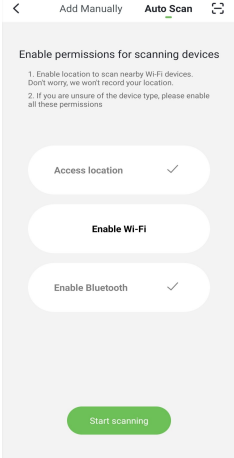
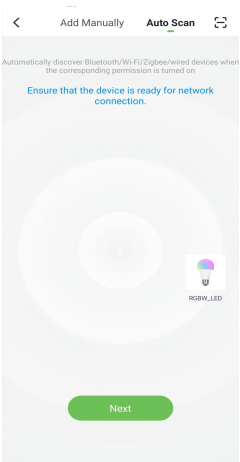
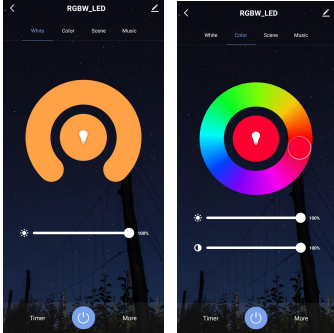

FIG.4

## APP connection steps

1	2	3
 <p data-bbox="197 510 432 551"><b>WG</b> Westgate Smart</p> <p data-bbox="140 618 304 645">Download APP</p> <p data-bbox="140 676 555 759">1. Scan above code 2. or search "Westgate Smart" in Apple Store or Google Play</p>	 <p data-bbox="619 730 906 757">Register account and login</p>	 <p data-bbox="1034 692 1465 757">Turn on the power to the light and tap the "+" icon on the top right corner of the app.</p>
4	5	6
 <p data-bbox="140 1330 475 1395">Select "Auto Scan" and turn on Bluetooth and GPS.</p>	 <p data-bbox="580 1314 970 1379">After scanning the fixture, click on the image to add it</p>	 <p data-bbox="1040 1292 1390 1395">Dimmer, color, scene and group settings can be made after the addition.</p>

### Question:

#### 1. If can not add fixtures

Reset the lamp, operation method: after the lamp is powered on, turn it on/off 5 times continuously (within 5S time).

#### 2. If color changes of multiple fixtures are not synchronized

Place fixtures that need to be synchronized in the same group

### After installation, please

- check whether the lighting fixture is firmly fixed.
- check whether wires are connected correctly.

At last, turn on the power, and check if the lighting fixture works well. If not, please turn off the power and contact with local dealer.

**Warning: the luminaire shall be installed by qualified electrician.**